

REV.	DATE	ECO	DESCRIPTION	BY	CK	APP
-	8/8/2013	N/A	INITIAL RELEASE	GDR	N/A	N/A

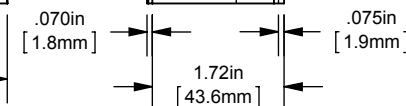

BACK VIEW
ADDER
(MPDB66230)
SHOWN

DIMENSIONS IN [] ARE MILLIMETERS

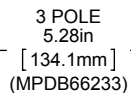
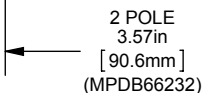
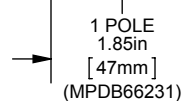
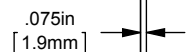
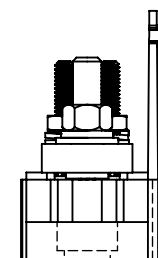
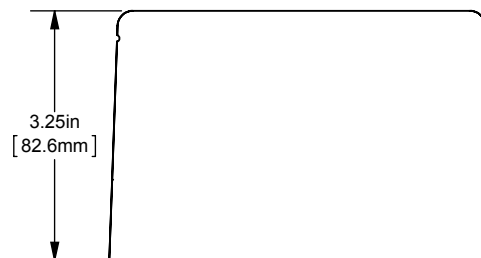
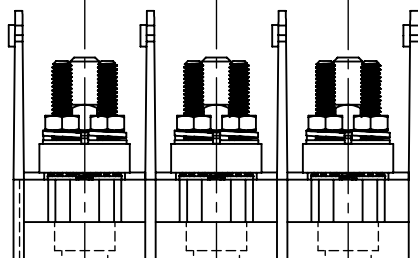
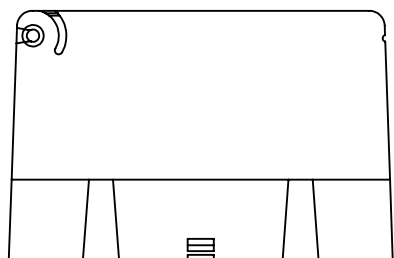
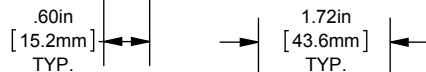
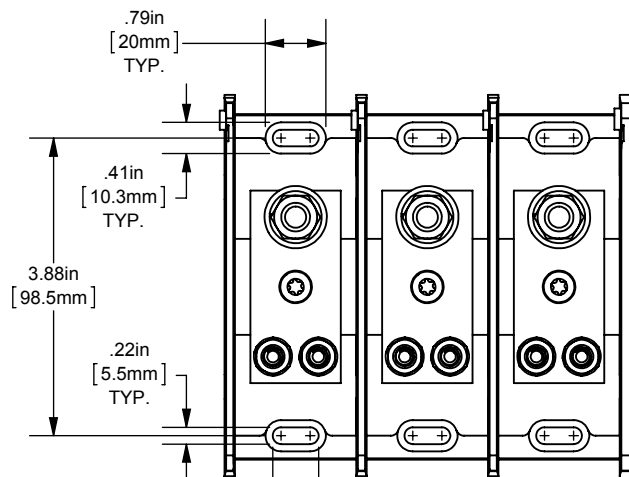

MERSEN USA NEWBURYPORT-MA, LLC
374 MERRIMAC STREET
NEWBURYPORT, MA 01950

MPDB(66230,66231,66232,66233)

OUTLINE DIMENSIONS
NOT TO BE USED FOR PRODUCTION

PRODUCT MANAGER

DESIGN ENGINEER

PDB 1-3P, ADDER COPPER INTERMEDIATE

SIGN:

SIGN:

(1)3/8-16 X 1-1/8 STD X (2)1/4-20 X 1-5/16 STD

701902

DATE:

DATE: (SEE ECO)