

REV.	DATE	ECO	DESCRIPTION	BY	CK	APP
-	8/26/2013	N/A	INITIAL RELEASE	GDR	N/A	N/A

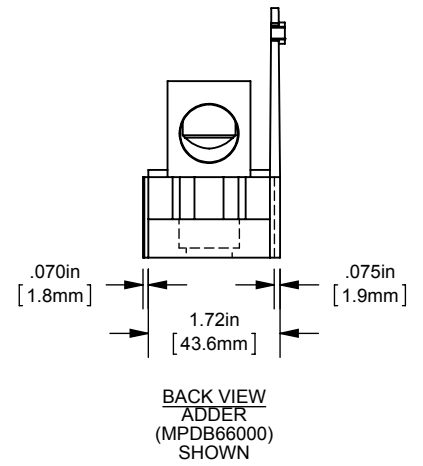

DIMENSIONS IN [] ARE MILLIMETERS

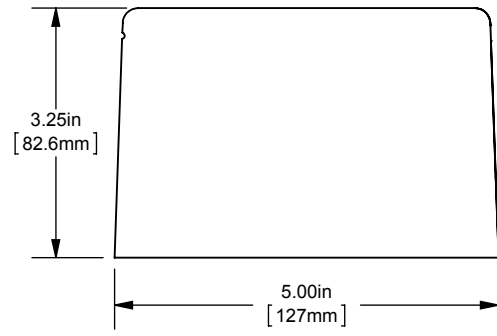
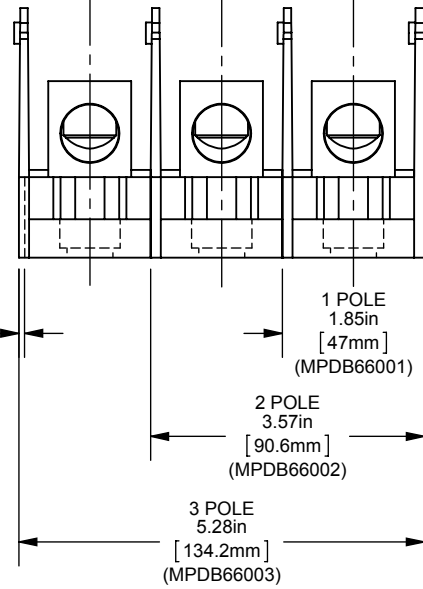
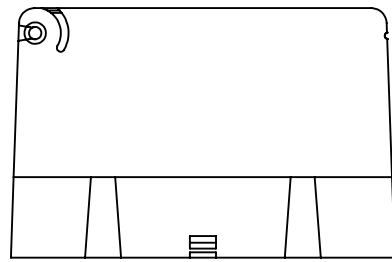
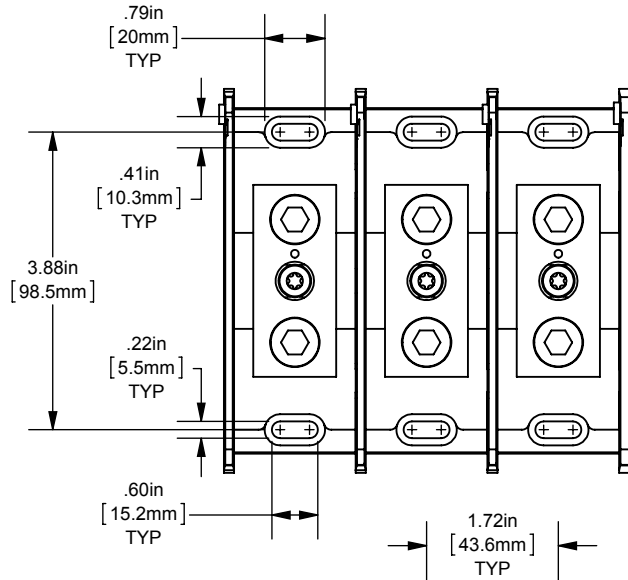

MERSEN USA NEWBURYPORT-MA, LLC
374 MERRIMAC STREET
NEWBURYPORT, MA 01950

MPDB(66000,66001,66002,66003)
PDB 1-3,ADDER COPPER INTERMEDIATE
(1) 350-6 X (1) 350-6

OUTLINE DIMENSIONS
NOT TO BE USED FOR PRODUCTION

701975

PRODUCT MANAGER
SIGN:
DATE:

DESIGN ENGINEER
SIGN:
DATE: (SEE ECO)