

REV.	DATE	ECO	DESCRIPTION	BY	CK	APP
-	8/8/2013	N/A	INITIAL RELEASE	GDR	N/A	N/A

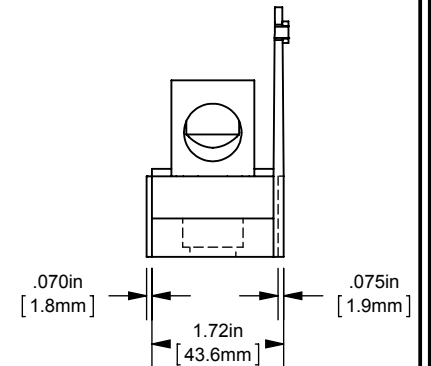

BACK VIEW
ADDER
(MPDB66010)
SHOWN

DIMENSIONS IN [] ARE MILLIMETERS

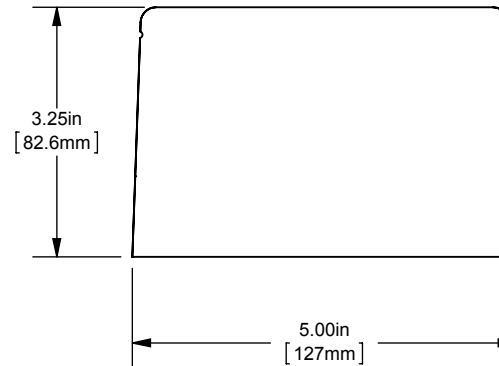
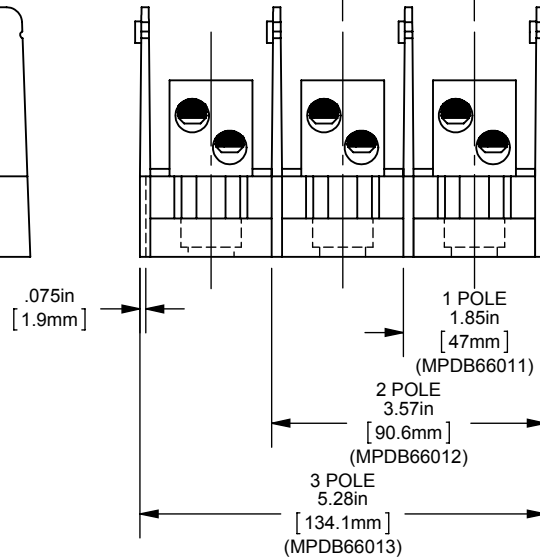
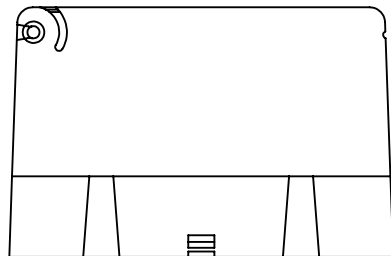
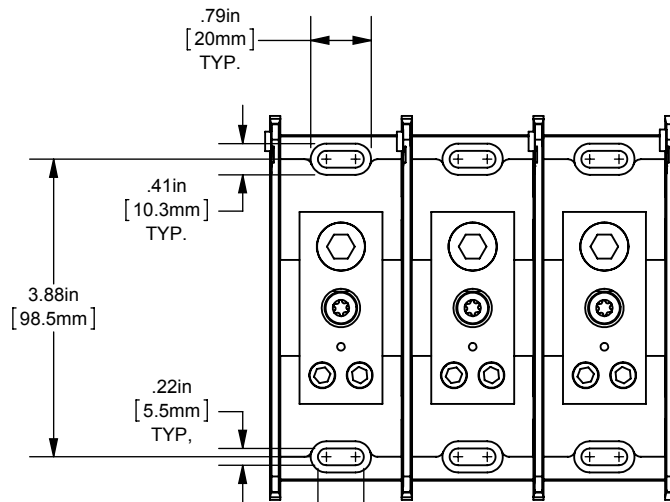

MERSEN USA NEWBURYPORT-MA, LLC
374 MERRIMAC STREET
NEWBURYPORT, MA 01950

MPDB(66010,66011,66012,66013)

PDB 1-3P,ADDER COPPER INTERMEDIATE

(1) 350-6 X (2) 2/0-14

OUTLINE DIMENSIONS
NOT TO BE USED FOR PRODUCTION

701898

PRODUCT MANAGER

SIGN:

DATE:

DESIGN ENGINEER

SIGN:

DATE: (SEE ECO)