

REV.	DATE	ECO	DESCRIPTION	BY	CK	APP
-	8/23/2013	N/A	INITIAL RELEASE	GDR	N/A	N/A

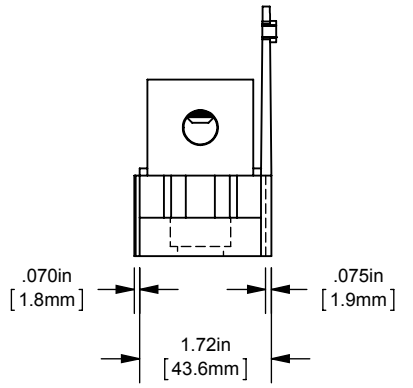

BACK VIEW
ADDER
(MPDB66590)
SHOWN

DIMENSIONS IN [] ARE MILLIMETERS

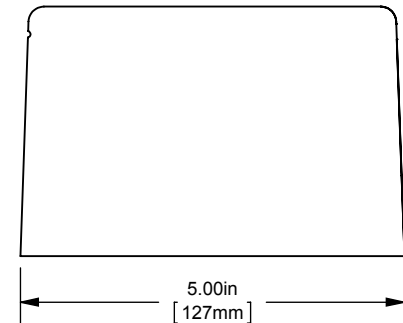
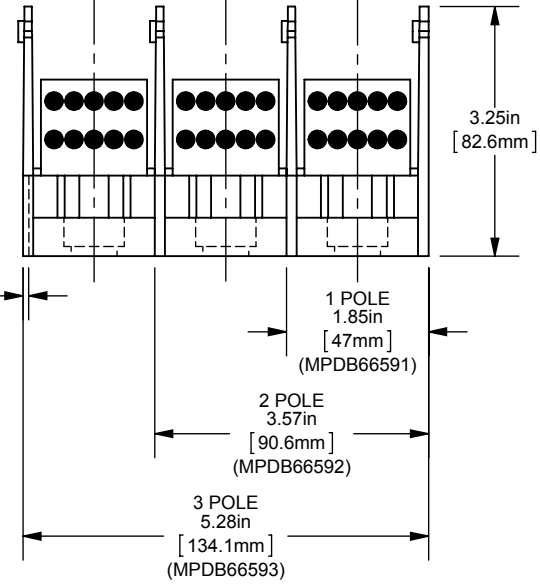
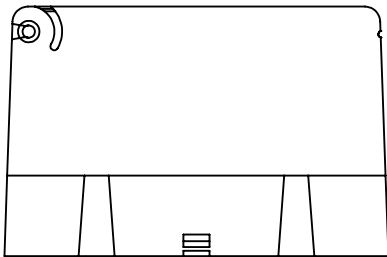
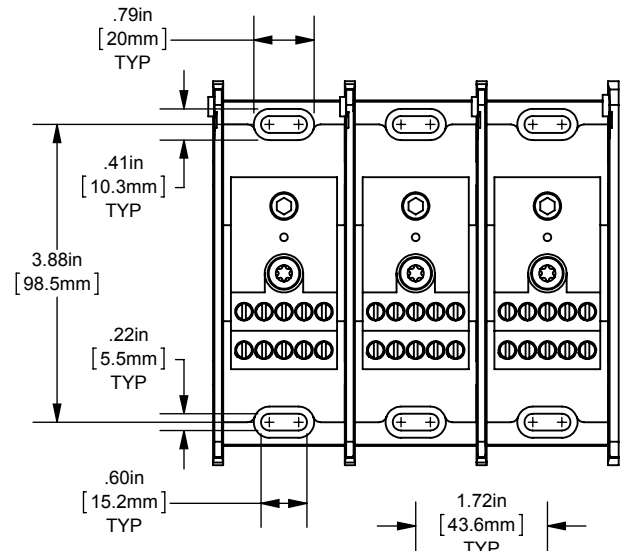

MERSEN USA NEWBURYPORT-MA, LLC
374 MERRIMAC STREET
NEWBURYPORT, MA 01950

MPDB(66590,66591,66592,66593)
PDB 1-3P,ADDER COPPER INTERMEDIATE
(1) 2/0-14 X (10) 6-14

OUTLINE DIMENSIONS
NOT TO BE USED FOR PRODUCTION

701931

PRODUCT MANAGER
SIGN:
DATE:

DESIGN ENGINEER
SIGN:
DATE: (SEE ECO)