

REV.	DATE	ECO	DESCRIPTION	BY	CK	APP
-	8/30/2013	N/A	INITIAL RELEASE	GDR	N/A	N/A

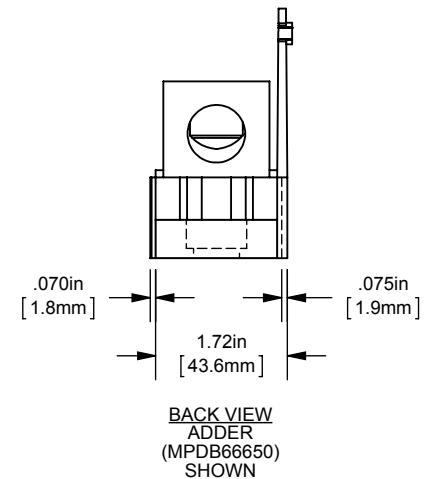

DIMENSIONS IN [] ARE MILLIMETERS

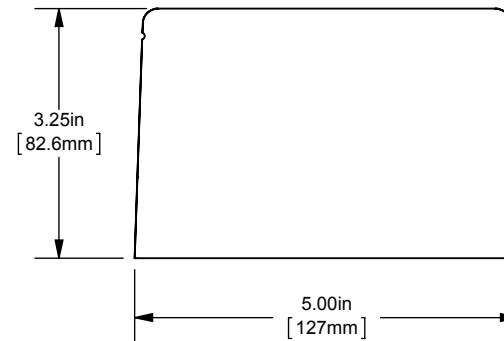
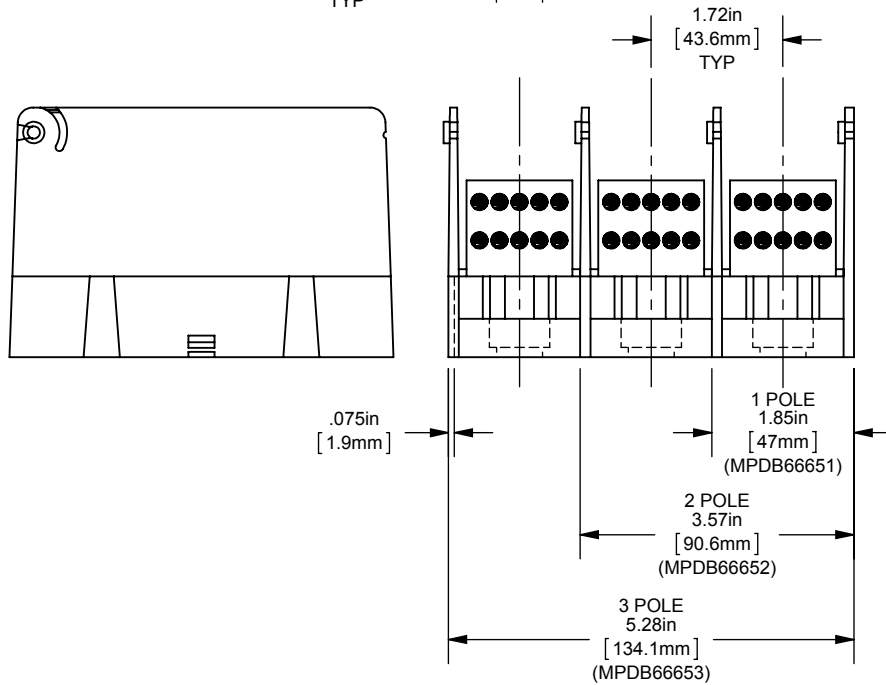
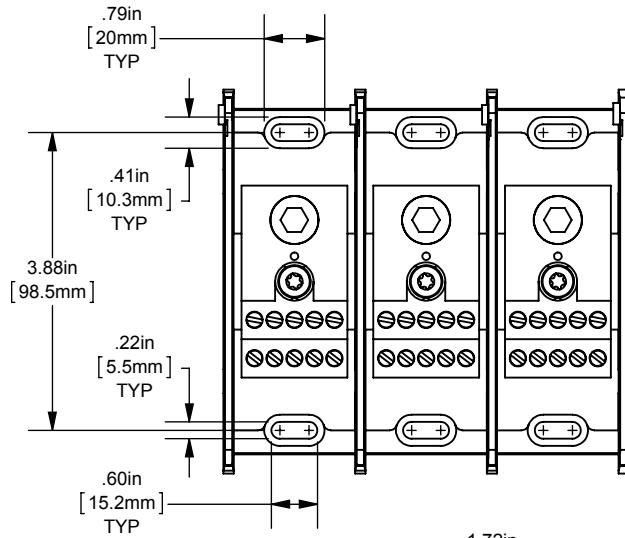

MERSEN USA NEWBURYPORT-MA, LLC
374 MERRIMAC STREET
NEWBURYPORT, MA 01950

MPDB(66650,66651,66652,66653)

PDB 1-3, ADDER COPPER INTERMEDIATE

(1)350-6 X (10)6-14

OUTLINE DIMENSIONS
NOT TO BE USED FOR PRODUCTION

701990

PRODUCT MANAGER

SIGN:

DATE:

DESIGN ENGINEER

SIGN:

DATE: (SEE ECO)